



*LISTE DE PIECES*

19/04/2016

<i>Produit</i>	397971 - ABONDANCE 500 M1
<i>Modèle</i>	> 300L STEATITE & BLINDEE
<i>Marque</i>	STYX
<i>Date</i>	01/10/2012

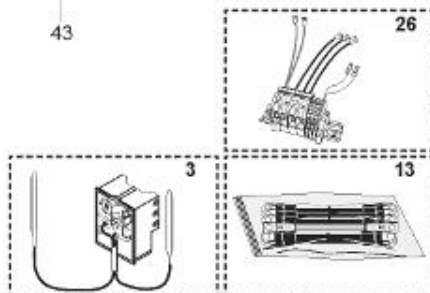
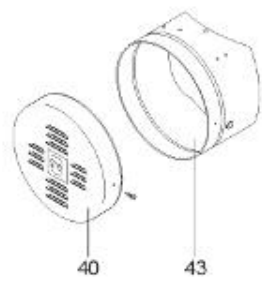
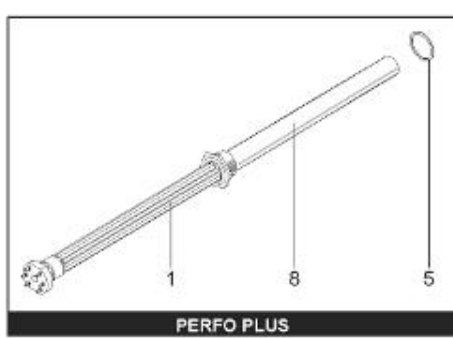
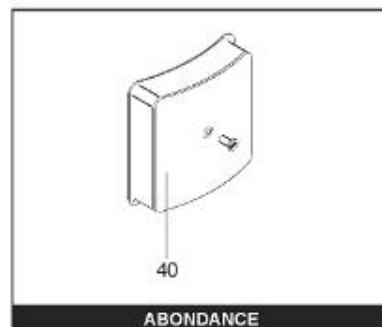
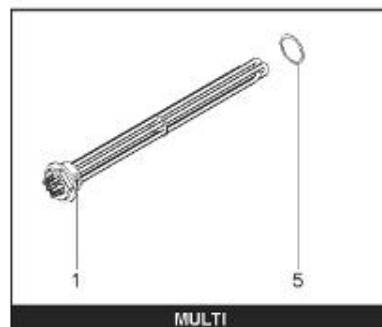
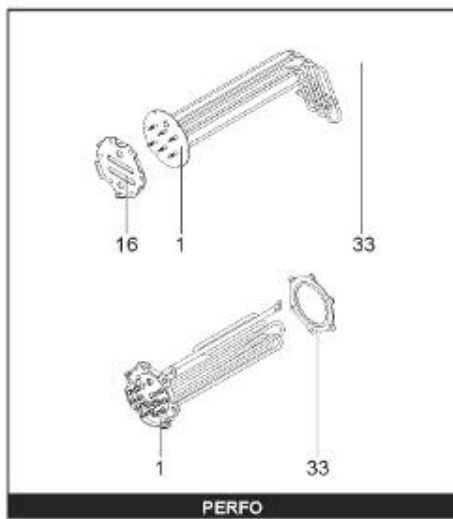
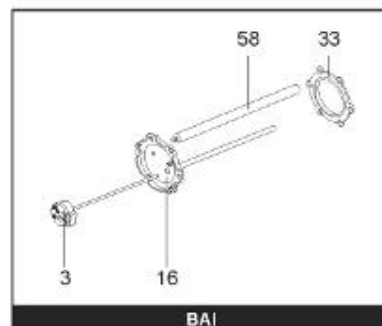
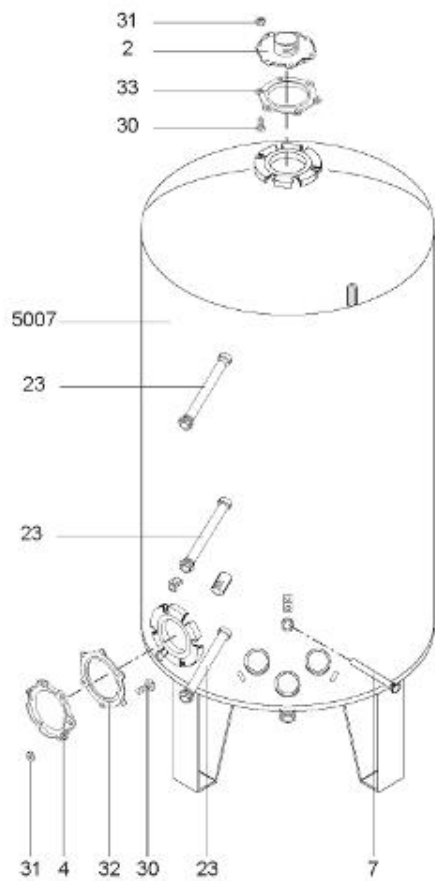

Table		PERFO. - MULTPUISSANCE - ABOND. - BAI							
Rep.	Référence	ALIAS	Désignation	Remplacé par	Date début	Date fin	Multiple de vente	Tarif Public Unitaire HT	
2	336204		BRIDE 110 SUP.				1		
4	923150		EMBASE D.110 AVEUGLE				1		
23	319524		ANODE D:21 L:598				1		
30	918061		VIS M 10-32 TETE CARREE				1		
31	918041		ECROU M 10				1		
32	343356		JOINT TRAPPE VISITE A 6 TROUS				1		
33	290139		JOINT DE BRIDE D.110 6 TROUS				1		
40	342068		ENJOLIVEUR DE TRAPPE				1		
5007	60002075		JAQUETTE M1 - 500L (44302000)				1		