

DMV 24

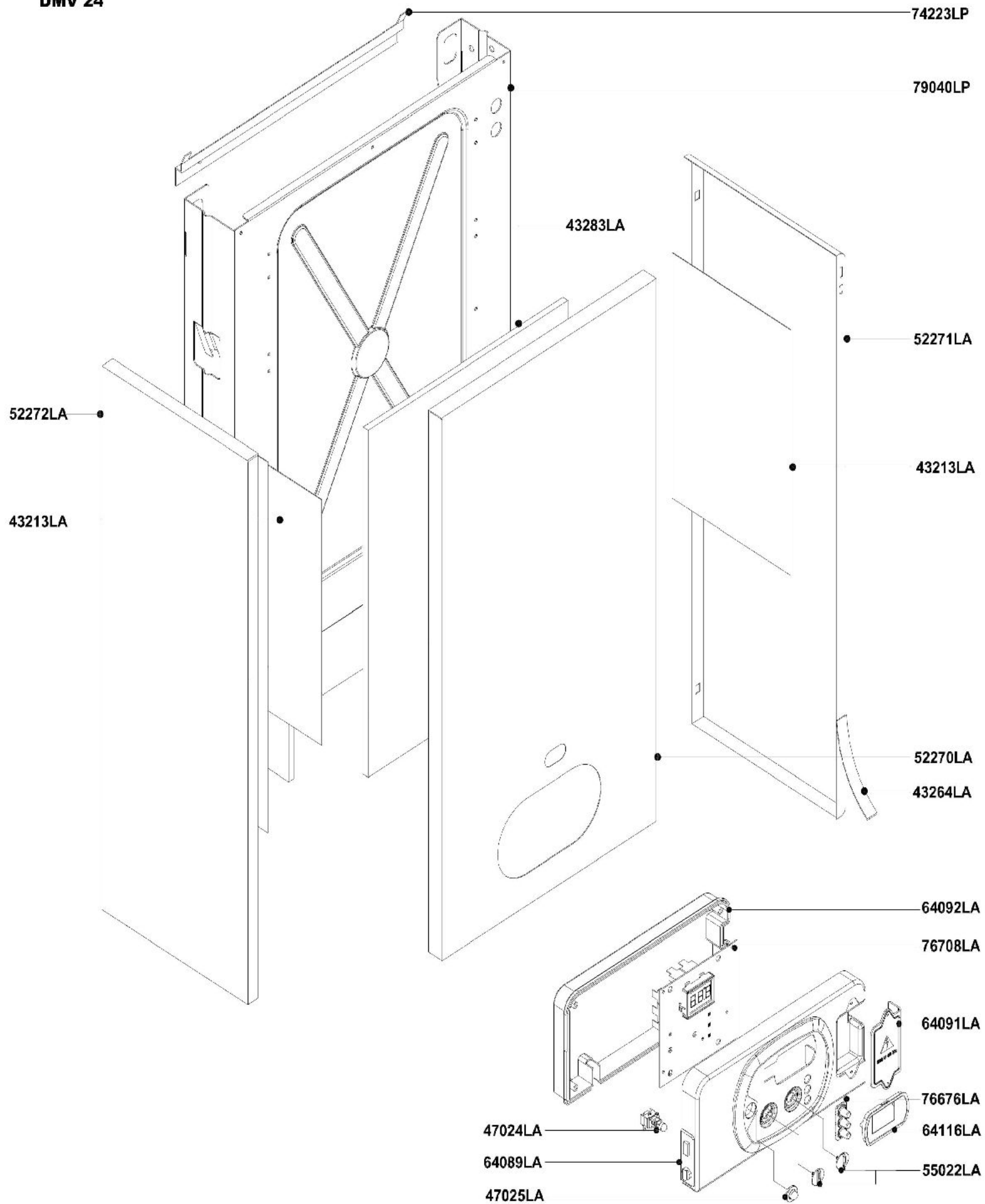

DMV 24

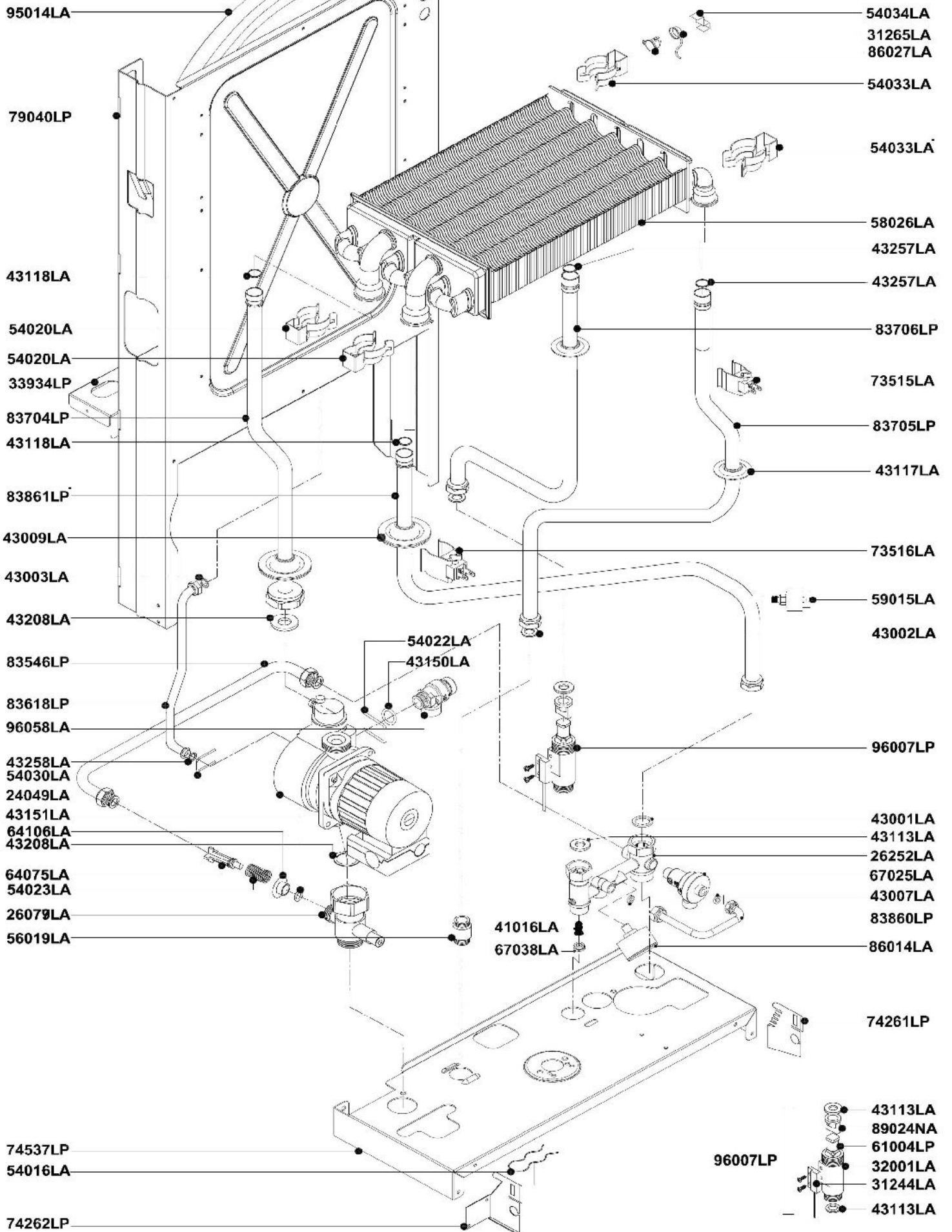

DMV 24

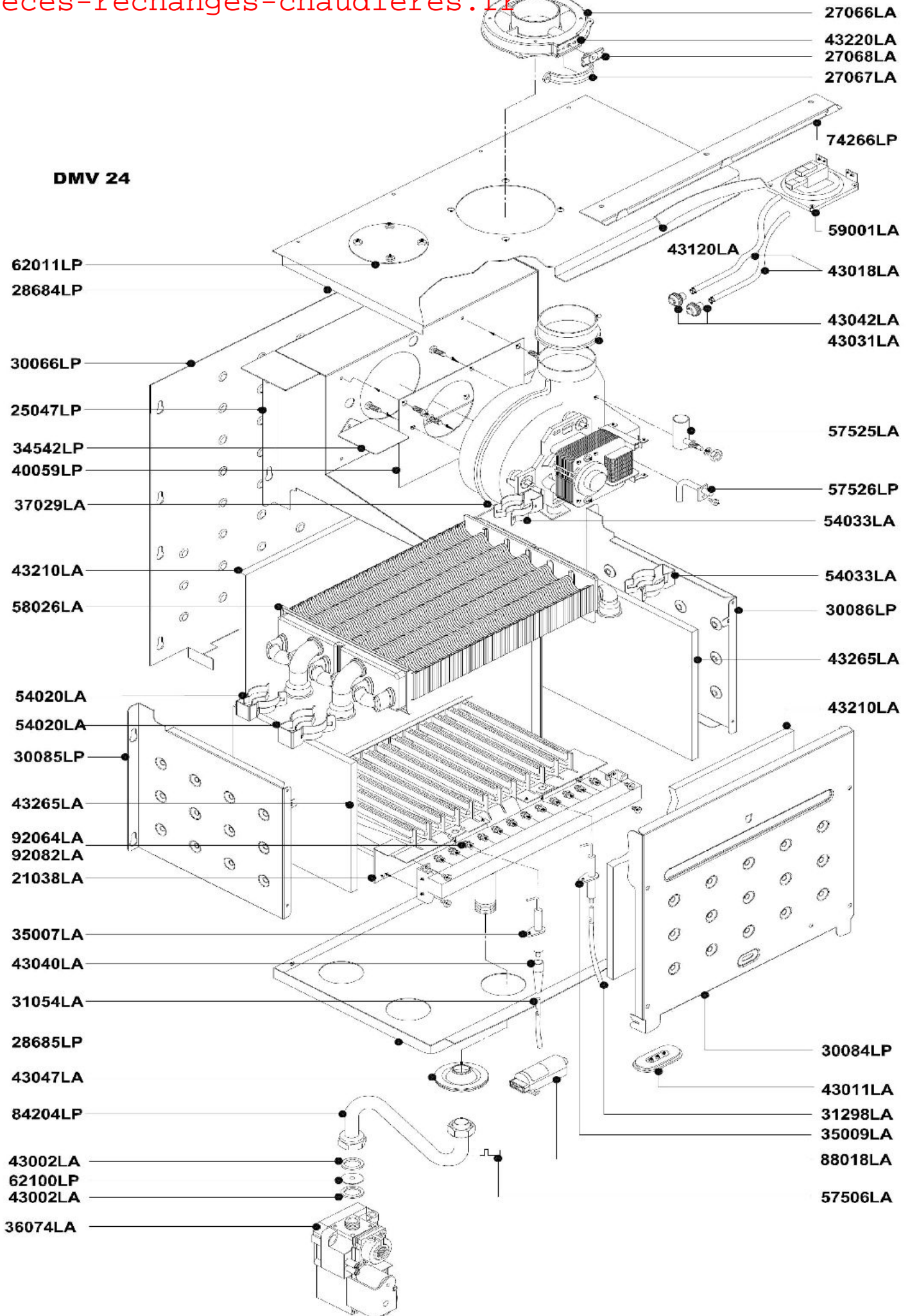

DMV 24

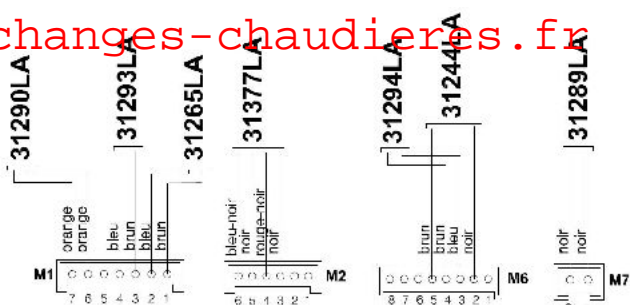

**CARTE ELECTRIQUE MODULATION-DT ELITE - SM20020
COD. 76708LA**

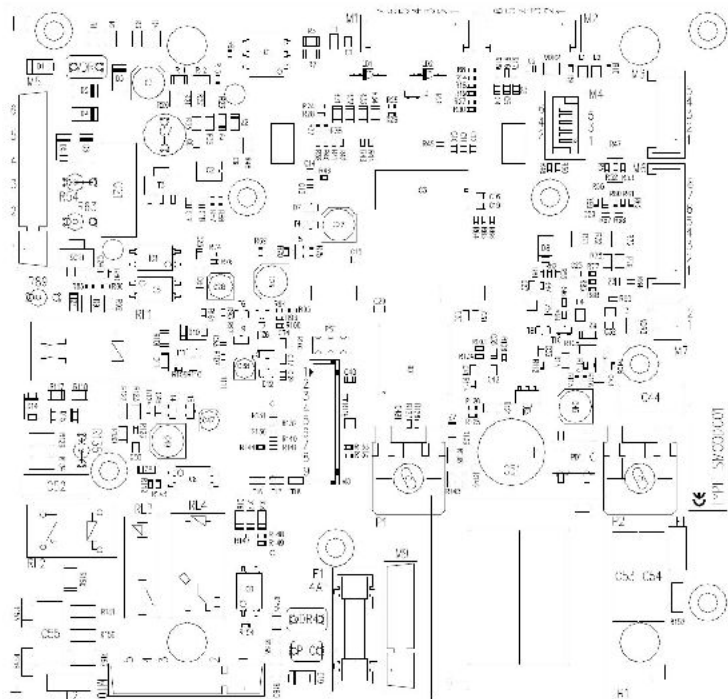

31287LA

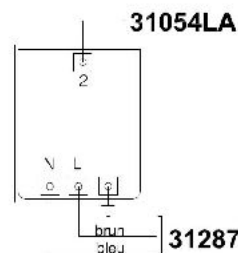
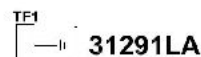
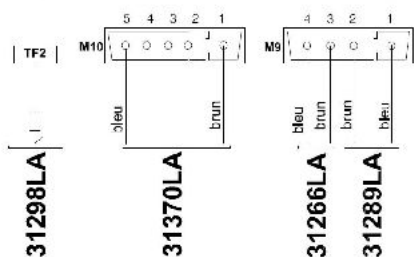
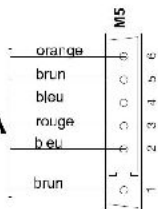

**TRANSFORMATEUR
AC1 230VAC 25HZ COD. 88018LA**

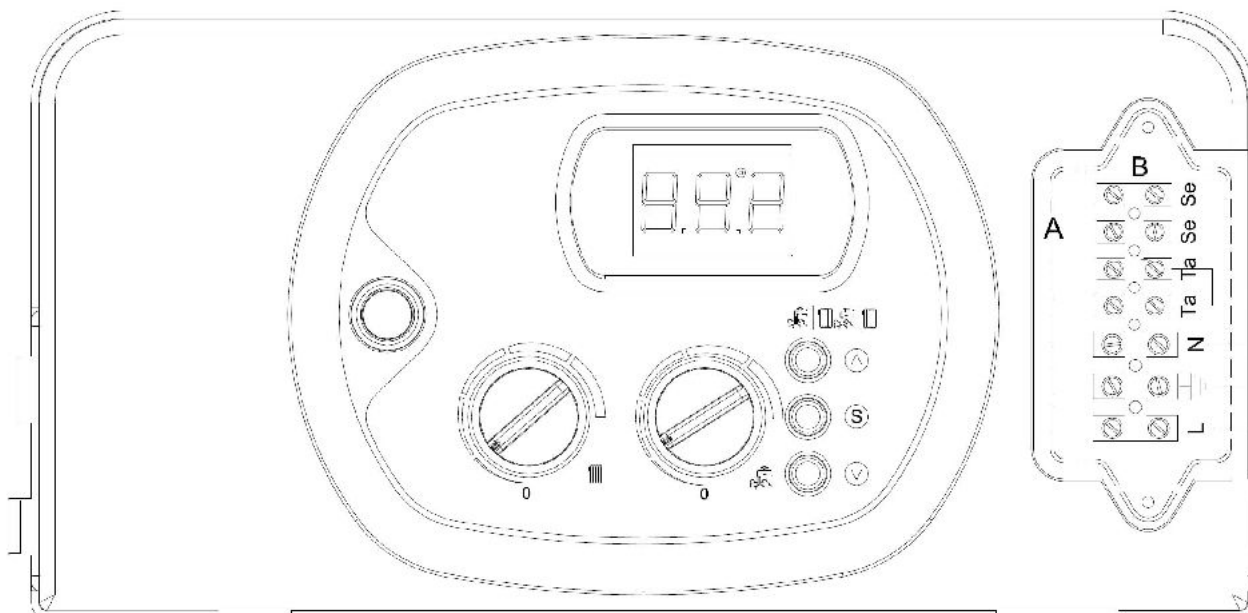

bleu
auto/volt
brun
31289LA

Ind	Piece	Designation	Type	Ind	Piece	Designation	Type
1-1	74223LP	PLAQUE SUPPORT CHAUDIEREMIC	SC	2-31	61004LP	PISTON FLUSSOSTAT COMPLET	U
1-10	64091LA	COUVERCLE POUR BARRETTE DE	SC	2-33	59015LA	PRESSOSTAT EAU LAITON	U
1-11	76676LA	GROUPE 3 BOUTONS	U	2-34	73516LA	SONDE CHAUFFAGE	U
1-12	64116LA	ADAPTATEUR DISPLAY CARTE ELE	SC	2-35	83705LP	TUBE D.14 EAU CHAUDE SANITAI	SC
1-13	55022LA	SELECTEUR TABLEAU DE COMMAN	U	2-36	73515LA	SONDE SANITAIRE	U
1-14	47025LA	BOUCHON POUR L5 BLANC	U	2-37	83706LP	TUBE D.14 SANUTAIRE FROID M24	SC
1-15	64089LA	DEVANT DE TABLEAU	SC	2-38	43257LA	JOINT	ATS
1-16	47024LA	INTERRUPTEUR L5 UNIPOLAIRE 16A	U	2-39	43257LA	JOINT	ATS
1-17	52272LA	HABILLAGE LATERL GAUCHE RBS M	SC	2-4	54020LA	RESSORT FIXATION ECHANGEUR	SC
1-2	79040LP	CHASSIS M24	SC	2-40	58026LA	ECHANGEUR BITHERMIQUE PRB2	U
1-3	43283LA	PARTIE FRONTALE ISOLATION M24+	SC	2-41	54033LA	EPINGLE DE FIXATION SANITAIRE	SC
1-4	52271LA	HABILLAGE LATERAL DROIT RBS	SC	2-42	86027LA	THERMOSTAT SURETE 90° 86027	U
1-5	43213LA	COLLANT ALUMINIUM DROIT/GAUC	SC	2-43	31265LA	CABLE THERMOSTAT SURETE	ATS
1-6	52270LA	HABILLAGE FRONTALE RBS M24 SA	SC	2-44	54034LA	EPINGLE DE FIXATION THERMOS	SC
1-7	43264LA	JOINT ADHESIF ISOLATION NOIR	SC	2-5	33934LP	BRIDE CHASSIS+ FIXATION VASE	SC
1-8	64092LA	CARTER DU PANNEAU OBLO	SC	2-6	83704LP	TUBE D.18 RETOUR M24	SC
1-9	76708LA	CARTE PRINCIPALE	U	2-7	83861LP	TUBE D.18 DEPART M24	SC
2-1	95014LA	VASE EXPANSION LT 6 3/8 BITH	U	2-8	43009LA	FB10/1 JOINT SILICONE/ROUGE R	SC
2-10	83618LP	EXPANSION VESSEL D.10 PIPE M242	SC	2-9	83546LP	TUBE D.8 BY PASS	SC
2-11	43258LA	JOINT	ATS	3-1	62011LP	BOUCHON D.100 CHAMBRE ETAN	SC
2-12	54030LA	PINCE FIXATION TUBE VASE EXPAN	SC	3-10	54020LA	RESSORT FIXATION ECHANGEUR	SC
2-13	24049LA	CIRCULATEUR	U	3-11	30085LP	PAROI LATERAL DROIT CHAMBRE	SC
2-14	43151LA	JOINT BY-PASS/REGULAT. M.PLEX	ATS	3-12	43265LA	PLAQUE DE FIBRE CERAMIQUE L	ATS
2-15	64106LA	BAGUE DE BY PASS *M24	ATS	3-13	21038LA	BRULEUR 12NP M24 METHANE 21	U
2-16	64075LA	CORPS BY-PASS M.PLEX 64075LA	ATS	3-14	35007LA	ELECTRODE D'ALLUMAGE 35007L	U
2-17	54023LA	RESSORT BY-PASS M.PLEX	ATS	3-15	43040LA	COUVERCLE ELECTRODE SIL/RO	U
2-18	26079LA	COLLECTEUR CIRCULATEUR M24+B	ATS	3-16	31054LA	CABLE ELECTRODE DALLUMAGE	U
2-19	56019LA	NIPPLES 1/2 E.24X29 RESSORT SLIM	SC	3-17	28685LP	PARTIE INFERIEUR CHAMBRE ET	SC
2-2	79040LP	CHASSIS M24	SC	3-18	43047LA	JOINT CONIQUE BLANC V.GAS M2	SC
2-20	74537LP	BARETTE DE RACCORDEMENT-RBS	SC	3-19	84204LP	TUBE D.18 VANNE GAZ	SC
2-21	54016LA	RESSORT FIXATION GABARIT RACC	SC	3-2	28684LP	PARTIE SUPERIEUR CHAMBRE ET	SC
2-22	74262LP	PLAQUE GAUCHE SUPPORT PANNE	SC	3-20	62100LP	DIAPHRAGME VANNE GAZ 3/4"	ATS
2-23	54022LA	PINCE FIXATION M.PLEX	SC	3-22	36074LA	VANNE GAZ 3/4"	U
2-24	43150LA	JOINT M PLEX EPDM	U	3-23	57506LA	PRISE DE PRESSION 10X1 E11X23	SC
2-25	41016LA	FILTRE FLUXOSTATE 98 2844	ATS	3-24	88018LA	TRANSFORMATEUR 88018LA	U
2-26	67038LA	LIMITEUR DE DEBIT 12LT. ROUGE	ATS	3-25	35009LA	ELECTRODE IONISATION 35009LA	U
2-27	95007LP	FLUSSOSTAT ELECTRONIQUE RAC	ATS	3-26	31298LA	CABLE ELECTRODE DE DETECTI	U
2-29	31244LA	CABLE MICRO FLUSSOSTAT AVEC T	U	3-28	3084LP	PARTIE FRONTALE CHAMBRE DE	SC
2-3	43118LA	JOINT 123 D17.86 EPDM ECHANGEU	U	3-29	43210LA	FRONTAL+PARTIE POST.FIBRE C	ATS
2-30	32001LA	CORPS FLUSSOSTATE NYLON ZYTE	ATS	3-3	30066LP	PARTIE POSTERIEUR CHAMBRE	SC
3-30	43265LA	PARTIE FRONTALE ISOLATION	ATS				
3-31	30086LP	PAROI LATERAL GAUCHE CHAMBRE	SC				
3-32	54033LA	EPINGLE DE FIXATION SANITAIRE	SC				
3-33	57526LP	PRISE DE PRESSION M24/RHR25	ATS				

Ind	Piece	Designation	Type	Ind	Piece	Designation	Type
3-34	57525LA	PRISE DE DEPRESSION VENTURI	ATS				
3-35	43031LA	MANCHON D.54 ELECTROVENTILATE	ATS				
3-36	43042LA	JOINT SIL/ROU POUR TUBE	ATS				
3-37	43018LA	TUBE SILICONE D8*4	ATS				
3-38	43120LA	JOINT ADHESIF AEROSTOP	SC				
3-39	59001LA	PRESSOSTAT AIR C6065AH1095 CE	U				
3-4	25047LP	HOTTE EVACUATION FUMEE M24	ATS				
3-40	74266LP	ETRIER FIXATION CHASSIS	SC				
3-41	27067LA	COLLIER INSPECTION FUMEE	SC				
3-42	27068LA	PLAQUE DE FERMETURE INSPECT.	SC				
3-44	27066LA	INSPECTION FUMEE	SC				
3-5	34542LP	DEFLECTEUR GAUCHE HOTTE FUM	ATS				
3-6	40059LP	BRIDE VENTILATEUR RBS M24	ATS				
3-7	37029LA	VENTILATEUR	U				
3-8	43210LA	FRONTAL+PARTIE POST.FIBRE CER	ATS				
3-9	58026LA	ECHANGEUR BITHERMIQUE PRB255	U				
4-1	31290LA	CABLE INTERUPTEUR	ATS				
4-10	31054LA	CABLE ELECTRODE DALLUMAGE 31	U				
4-11	31266LA	CABLE VENTILATEUR	ATS				
4-12	31370LA	CABLE CONNECTEUR CIRCULATEU	SC				
4-13	31298LA	CABLE ELECTRODE DE DETECTION	SC				
4-14	88018LA	TRANSFORMATEUR 88018LA	U				
4-15	31289LA	CABLE ALIM.+THERMOS.AMB.SM 20	SC				
4-2	31293LA	CABLE PRESSOSTAT DT-THERMOS	ATS				
4-3	31265LA	CABLE THERMOSTAT SURETE	ATS				
4-4	31377LA	CABLE SONDE SANITAIRE	U				
4-5	31294LA	CABLE PRESSOSTAT EAU	ATS				
4-6	31244LA	CABLE MICRO FLUSSOSTAT AVEC T	U				
4-7	31289LA	CABLE ALIM.+THERMOST.AMB. SM2	SC				
4-8	31287LA	cABLE CARTE ELECT./VANNE GAZ/T	ATS				
4-9	31291LA	CABLE CARTE DE MODULATION CH	SC				