

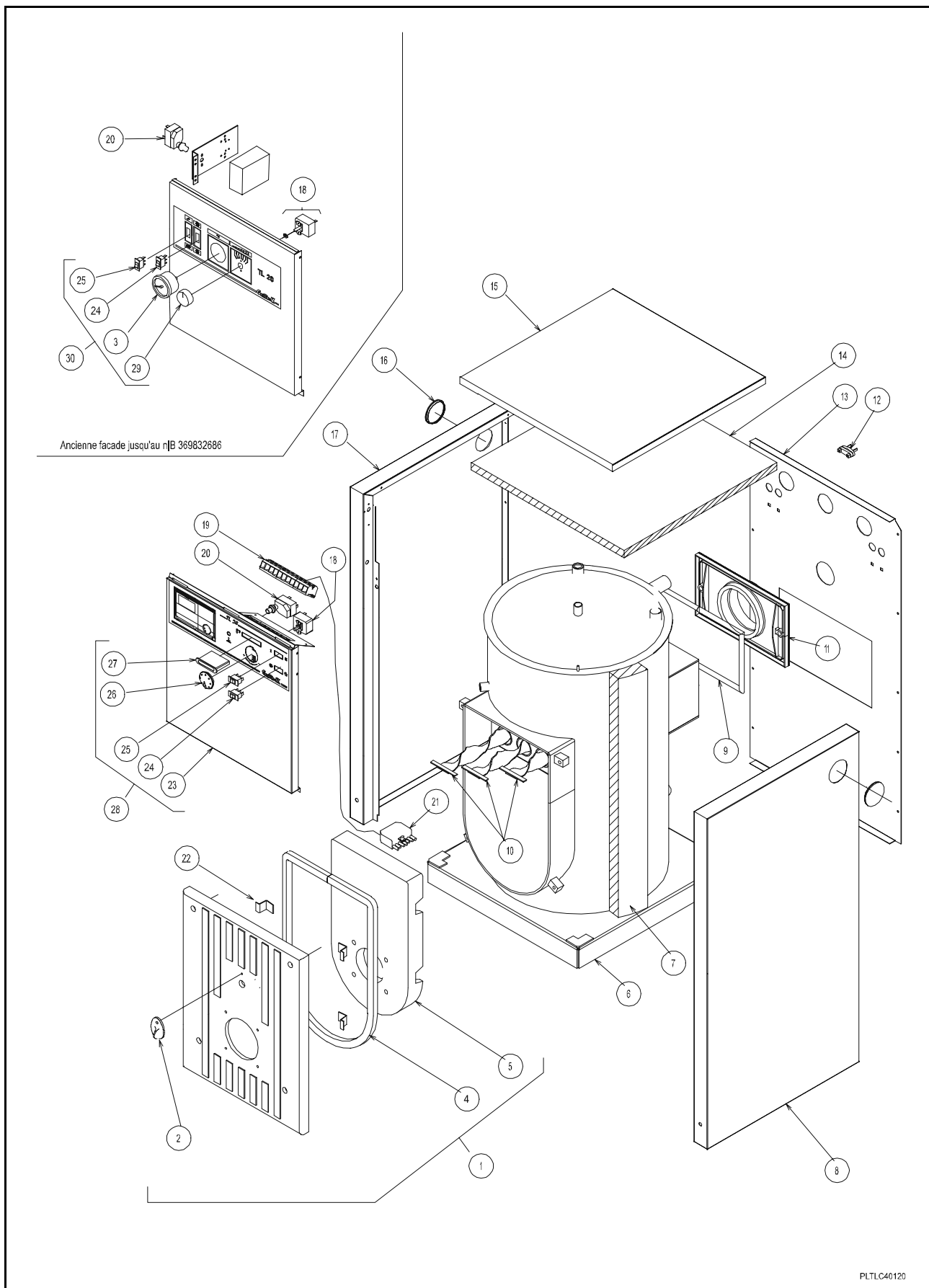









ZTLC4.0120-ZTLC4.0135



TL GAZ 20-35 C

1	<p> REF : 87168204200</p> <p>PORTE BRULEUR COMPLETE TL 20</p>
2	<p> REF : 87168005630</p> <p>VOYANT DE VISE-FLAMME FONTE</p>
3	<p> REF : 87168000500</p> <p>THERMOMETRE CIRCUL 0/120° D.52 NOIR</p> <p>jusqu'au numéro N° 369832686</p>
4	<p> REF : 87168389420</p> <p>TRESSE 18x18 LG 1380 PORTE BRULEUR TL 20/25</p> <p>(porte bruleur TL 20/25)</p>
4	<p> REF : 87168389440</p> <p>TRESSE 18x18 LG 1520 PORTE BRUL.TL 30/35/40</p> <p>(porte bruleur TL 30/35/40)</p>
5	<p> REF : 87168141840</p> <p>ISOLANT PORTE BRULEUR (TL35)</p>
5	<p> REF : 87168203460</p> <p>ISOLANT PORTE BRULEUR TL20</p>
6	<p> REF : 87168139300</p> <p>CORPS/CHAUFFE EQUIPE TL 35C (PORTE FONTE)</p>
6	<p> REF : 87168202400</p> <p>CORPS / CHAUFFE EQUIPE TL 20C</p>
7	<p> REF : 87168204530</p> <p>ISOLATION LATERALE TL 20 C</p>
8	<p> REF : 87168128890</p> <p>COTE DROIT TL 30/35 C</p>
8	<p> REF : 87168206080</p> <p>COTE DROIT GRIS TL 20 C</p>
9	<p> REF : 87168389430</p> <p>TRESSE VERRE Ø11 LG960 SORTIE FUMEE TL 20/25</p> <p>(sortie de fumée TL 20/25)</p>
9	<p> REF : 87168389450</p> <p>TRESSE Ø11 LG 1150 SORTIE FUMEE TL30/35/40</p> <p>(sortie de fumée TL 30/35/40/60)</p>
11	<p> REF : 87168237690</p> <p>COUVERCLE FUMEE TL35 D.139/150</p>
11	<p> REF : 87168237700</p> <p>COUVERCLE FUMEE D.125 TL 20</p>

12	 REF : 87168125610 SERRE-CABLE PA 6.6 NATUREL
13	 REF : 87168134290 ARRIERE GRIS TL 35C
13	 REF : 87168206030 ARRIERE GRIS TL 20 C
14	 REF : 87168204570 ISOLATION DESSUS TL 20 C
15	 REF : 87168128920 DESSUS TL 35C/S (GRIS CLAIR)
15	 REF : 87168206020 DESSUS GRIS TL 20
16	 REF : 87168031340 BOUCHON PLASTIQ. NATUREL D.61
17	 REF : 87168206100 COTE GAUCHE GRIS TL 20 C
18	 REF : 87168316130 THERMOSTAT CHAUDIERE 60-80°C
19	 REF : 87168244740 REGLETTE 1014H SP 2311 LANG/VIS SS REP. SAAM
20	 REF : 87168419890 THERMOSTAT SECU LIM 100°C - CAP 1,5M (R)
21	 REF : 87168090080 CONNECTEUR WIELAND ST18 MAL7PTS SIMP COMPLET N/M
22	 REF : 87168329980 PATTE FIX.ISOL.REF.PLIEE TL/MEGALITHE
23	 REF : 87168238730 FACADE + LEXAN TL 20C à partir du numéro N° 369832687
23	 REF : 87168238800 FACADE + LEXAN TL 35C à partir du numéro N° 449840993
24	 REF : 87168079490 INTER INV UNIPOLAIRE NOIR/NOIR
25	 REF : 87168121620 INTER UNIPOLAIRE NOIR/LUMINEUX VERT

26	 REF : 87168188000 BOUTON AQUASTAT GEMINOX à partir des numéros N° 369832687 TL 20, N° 449840993 TL 35
27	 REF : 87168011350 THERMOMETRE RECT HORIZ 69x14 LG CAPIL.1500 MM à partir des numéros N° 369832687, N° 449840993 TL 35
28	 REF : 87168238310 FACADE AVANT EQUIPEE TL35C GEMINOX à partir du numéro N° 449840993
29	 REF : 87168011380 BOUTON THERMOSTAT NOIR jusqu'aux numéros N° 369832686 TL 20, N° 449840992 TL 35
30	 REF : 87168245310 FACADE EQUIPEE+DESSUS TL 20C jusqu'au numéro N° 369832686
30	 REF : 87168245330 FACADE EQUIPEE+DESSUS TL 35C jusqu'au numéro N° 449840992