

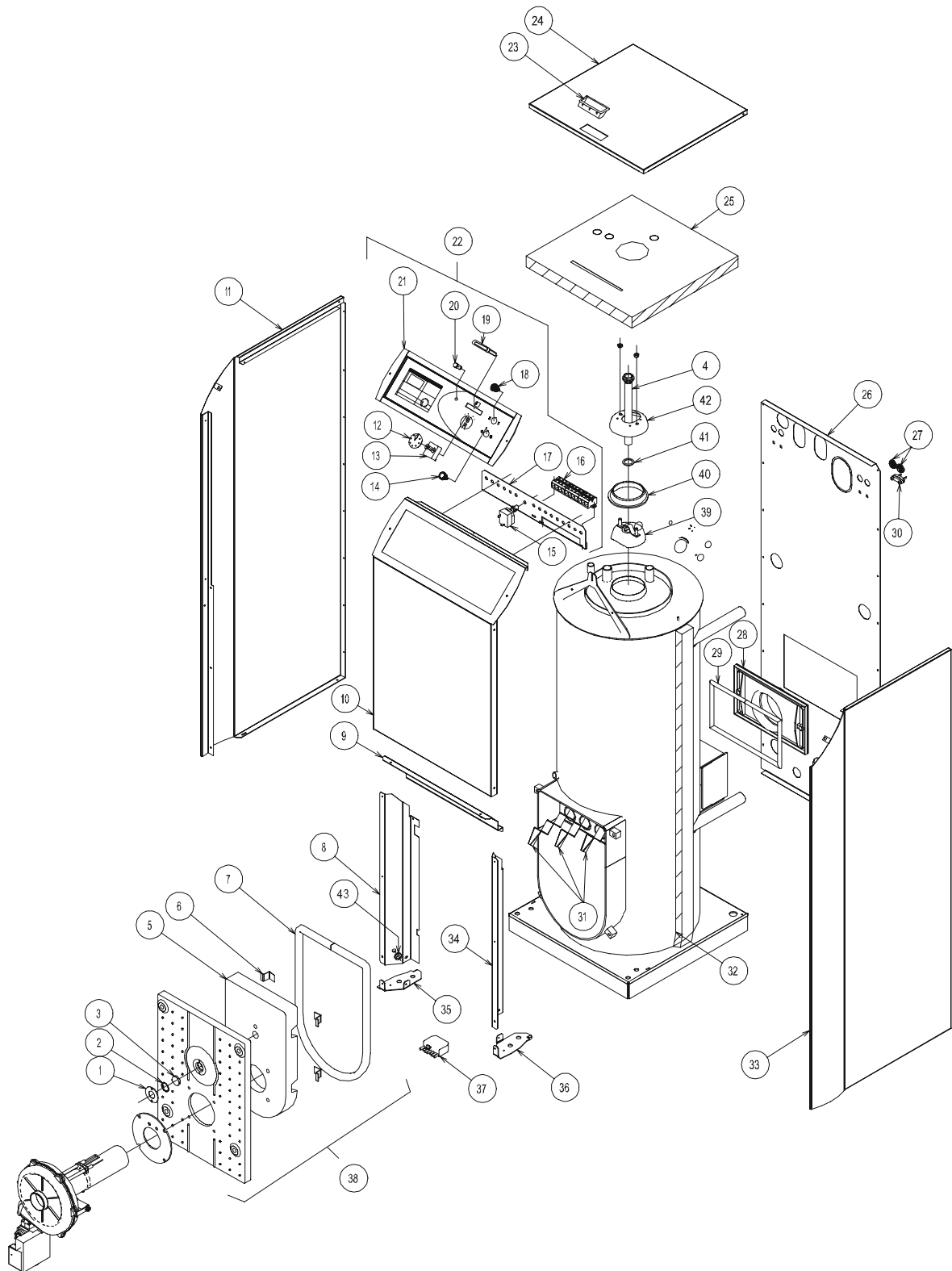































ZCTS4.0122-ZCTS4.0137



PLT.LS40122

CTL GAZ 20-35 S (DOUBLE CIRCUIT)

1	 REF : 87168293360 RONDEL.VISE FLAMME GALVA TL - OLIO 1500
2	 REF : 87168006920 RONDELLE ELASTIQUE INOX A2 -D30,4x25,5x0,3
3	 REF : 87168005820 HUBLOT BOROSILICATE D.30X5
4	 REF : 87168413690 ANODE + JOINT
5	 REF : 87168141840 ISOLANT PORTE BRULEUR (TL35)
5	 REF : 87168203460 ISOLANT PORTE BRULEUR TL20
6	 REF : 87168329980 PATTE FIX.ISOL.REF.PLIEE TL/MEGALITHE
7	 REF : 87168389420 TRESSE 18x18 LG 1380 PORTE BRULEUR TL 20/25 (porte bruleur TL 20/25)
7	 REF : 87168389440 TRESSE 18x18 LG 1520 PORTE BRUL.TL 30/35/40 (porte bruleur TL 30/35/40)
8	 REF : 87168292510 CACHE LATERAL G. GRIS TL 20
8	 REF : 87168293070 CACHE LAT. GAUCHE GRIS TL 35
9	 REF : 87168294300 CACHE HAUT PORTE GRIS TL 20 VENT.
9	 REF : 87168294330 CACHE HAUT PORTE GRIS TL 35 VENT.
10	 REF : 87168292590 FACADE GRISE TL 20S
10	 REF : 87168293320 FACADE AVANT GRISE TL 35S
11	 REF : 87168292640 COTE GAUCHE GRIS TL 20S
11	 REF : 87168293260 COTE GAUCHE GRIS TL 35S
12	 REF : 87168188000 BOUTON AQUASTAT GEMINOX

13	 REF : 87168316130 THERMOSTAT CHAUDIERE 60-80°C
14	 REF : 87168249030 INVERSEUR UNIPOLAIRE ROND D.23
15	 REF : 87168419890 THERMOSTAT SECU LIM 100°C - CAP 1,5M (R)
16	 REF : 87168244740 REGLETTE 1014H SP 2311 LANG/VIS SS REP. SAAM
17	 REF : 87168292320 SUP.BORNIER BLANC TL - FB--
18	 REF : 87168249040 INTER UNIPOLAIRE D.23 LUMINEUX VERT
19	 REF : 87168011350 THERMOMETRE RECT HORIZ 69x14 LG CAPIL.1500 MM
20	 REF : 87168032440 VOYANT ROUGE 230V TETE PLATE RONDE
21	 REF : 87168292760 TABLEAU CDE. + LEXAN TL 20
21	 REF : 87168293180 TABLEAU CDE. + LEXAN TL 35
22	 REF : 87168292780 TABLEAU CDE EQUIPE TL 20 GAZ
22	 REF : 87168293170 TABLEAU CDE. EQUIPE TL 35 GAZ
23	 REF : 87168189840 POIGNEE CLIPSABLE NOIRE PR EP1 82.5x25.5 (P2-41)
24	 REF : 87168292310 DESSUS EQUIPE TL 20 C/S
24	 REF : 87168292810 DESSUS EQUIPE GRIS TL 35/60
25	 REF : 87168294960 ISOLATION DESSUS TL 20S
26	 REF : 87168133530 ARRIERE TL 35S (GRIS C LAIR)
26	 REF : 87168292560 ARRIERE GRIS TL 20S
27	 REF : 87168030710 PASSE-FIL SAREL

28	 REF : 87168237690 COUVERCLE FUMEE TL35 D.139/150
28	 REF : 87168237700 COUVERCLE FUMEE D.125 TL 20
29	 REF : 87168389430 TRESSE VERRE Ø11 LG960 SORTIE FUMEE TL 20/25 (sortie de fumée TL 20/25)
29	 REF : 87168389450 TRESSE Ø11 LG 1150 SORTIE FUMEE TL30/35/40 (sortie de fumée TL 30/35/40/60)
30	 REF : 87168125610 SERRE-CABLE PA 6.6 NATUREL
31	 REF : 87168281600 TURBULATEUR ZIGZAG TL
32	 REF : 87168310320 ISOLANT LATERAL TL 20S DOUBLE CIRCUIT
32	 REF : 87168310400 ISOLANT LATERAL TL 35S DOUBLE CIRCUIT
33	 REF : 87168292620 COTE DROIT GRIS TL 20S
33	 REF : 87168293240 COTE DROIT GRIS TL 35S
34	 REF : 87168292490 CACHE LATERAL D. GRIS TL 20
34	 REF : 87168293050 CACHE LAT. DROIT GRIS TL 35
35	 REF : 87168292700 PAT.G.FIX.COT/SOC. PLIEE TL 20
35	 REF : 87168293130 PAT.G.FIX.COT/SOC PLIEE TL 35
36	 REF : 87168292680 PAT.D.FIX.COT/SOC. PLIEE TL 20
36	 REF : 87168293110 PAT.D.FIX.COT/SOC PLIEE TL 35
37	 REF : 87168090080 CONNECTEUR WIELAND ST18 MAL7PTS SIMP COMPLET N/M

38	 REF : 87168293380 PORTE BRULEUR COMPLETE TL 20
38	 REF : 87168293390 PORTE BRULEUR COMPLETE TL 35
39	 REF : 87168199840 TRAPPE SAV ANODE
39	 REF : 87168263820 TRAPPE POUR BALLON SANS ANODE
40	 REF : 87168101870 JOINT TRAPPE DE VISITE
41	 REF : 87168181030 JOINT QUALITE AFM34 D.36X26,5X2
42	 REF : 87168294770 BRIDE DE TRAPPE VISITE
43	 REF : 87168167080 PASSE-FIL D.10 POUR PERCAGE D.12