



LISTE DE PIECES

14/04/2016

<i>Produit</i>	3010597 - ARI 270 STAB 570 HPC MT
<i>Modèle</i>	270L STABLE STEATITE
<i>Marque</i>	ARISTON
<i>Date</i>	08/12/2015

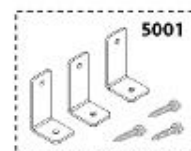
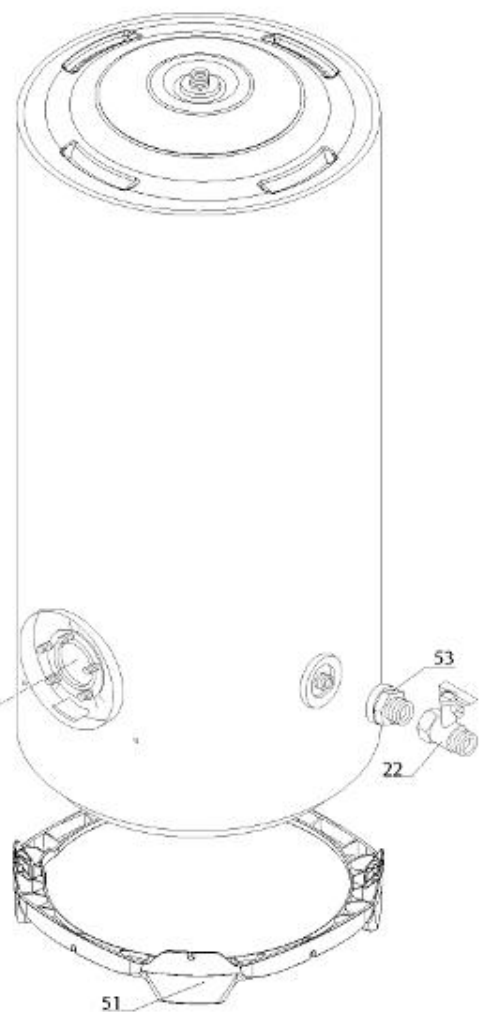
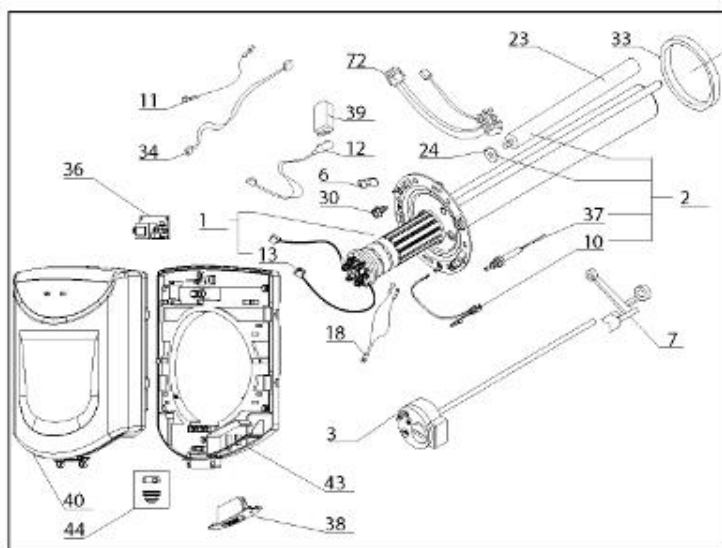
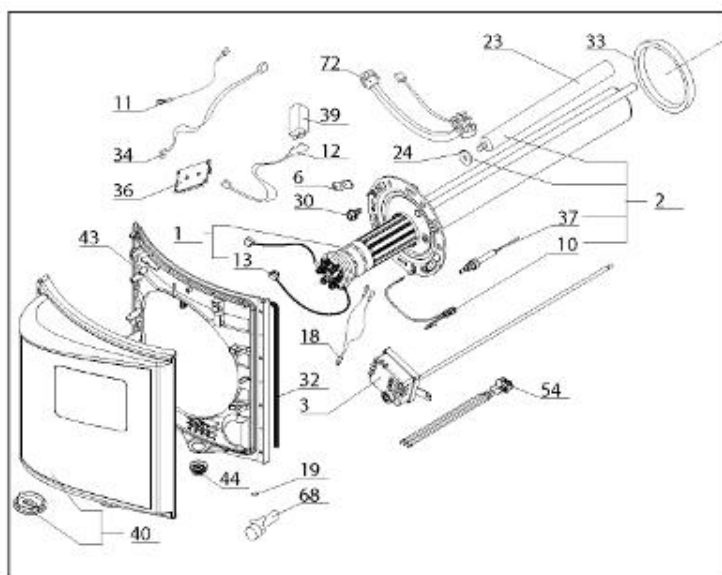
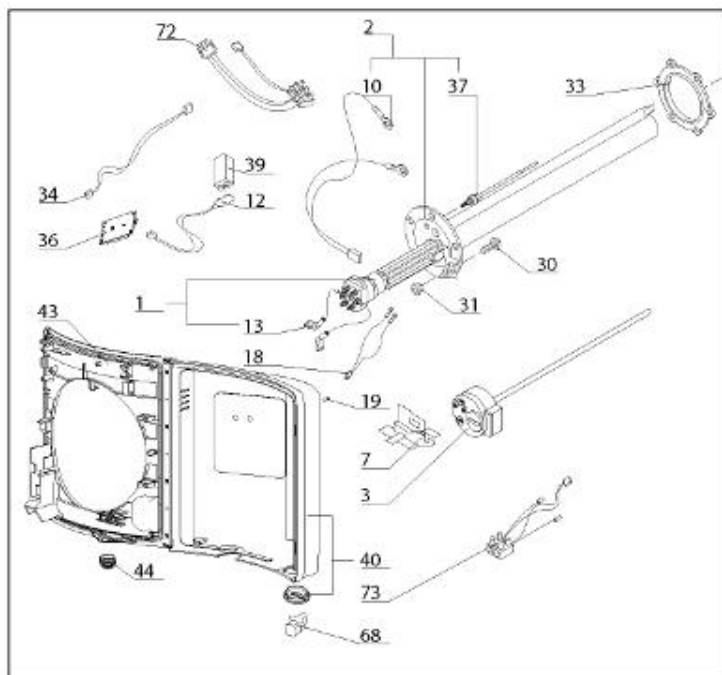

Table		HPC							
Rep.	Référence	ALIAS	Désignation	Remplacé par	Date début	Date fin	Multiple de vente	Tarif Public Unitaire HT	
1	60000059-01		RESISTANCE STEATITE 3000W D.50		08/14		1		
2	60002293		EMBASE + ANODE PROTECH		08/14		1		
3	60001841		THERMOSTAT A CANNE L:450		08/14		1		
6	60072531		PATTE DE FIXATION		08/14		1		
10	60001108-01		CABLAGE ELECTRODE > C.I.		08/14		1		
11	60002273		CABLAGE DE MASSE		08/14		1		
12	60000938		CABLAGE BATTERIE				1		
13	61401781		CABLAGE (VIOLET)				1		
13	61401780		CABLAGE (VERT)				1		
13	61401779		CABLAGE (BRUN)				1		
18	60002294		LAMPE TEMOIN		08/14		1		
19	998576		VITRE LED L=10.8		08/14		1		
23	65102462		ANODE D:25.5 L:380 M8		08/14		1		
30	60000681		VIS DE FIXATION EMBASE M 8-14 (6 PCES)		08/14		1		
32	60002136		JOINT 9X4 L: 2500		08/14		1		
33	60000682		JOINT BRIDE D:121.7-105-11.5		08/14		1		
34	60000939		CABLAGE ELECTRODE > C.I.				1		
36	60002295		CIRCUIT IMPRIME (3 mA)		08/14		1		
37	65109749		ANODE PROTECH		08/14		1		
39	925298		BATTERIE 9V-170 MAH				1		
40	60002296		COUVERCLE BOITIER		08/14		1		
43	60000513		FOND DE BOITIER				1		
44	926044		EMBOUT PASSE CABLE				1		
53	926195		RACCORDS DIELECTRI. 3/4-75 A 300L KIT				1		
54	60000801		CABLAGE THERMOSTAT		08/14		1		
68	60002297		VOYANT ORANGE		08/14		1		
72	60000935		CABLAGE PUISSANCE				1		
5001	60002299		KIT DE FIXATION				1		