



LISTE DE PIECES

13/04/2016

<i>Produit</i>	3000032 - 200 AXVT TITANIUM +
<i>Modèle</i>	200L VERTICAL STEATITE
<i>Marque</i>	ARISTON
<i>Date</i>	13/04/2012

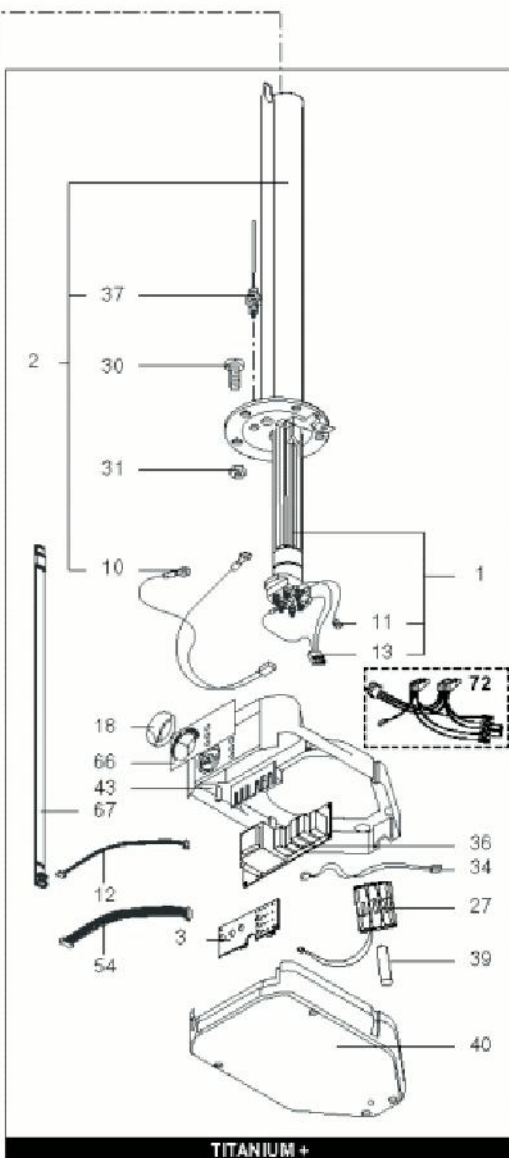
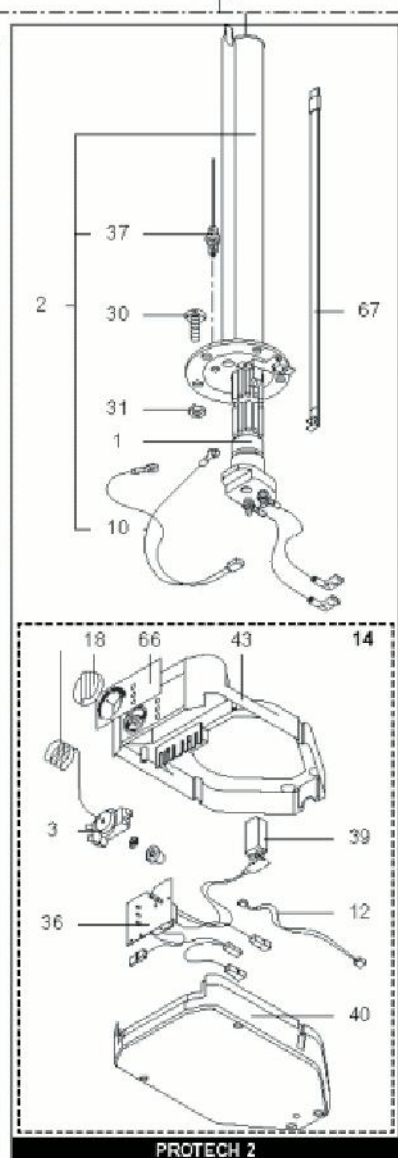
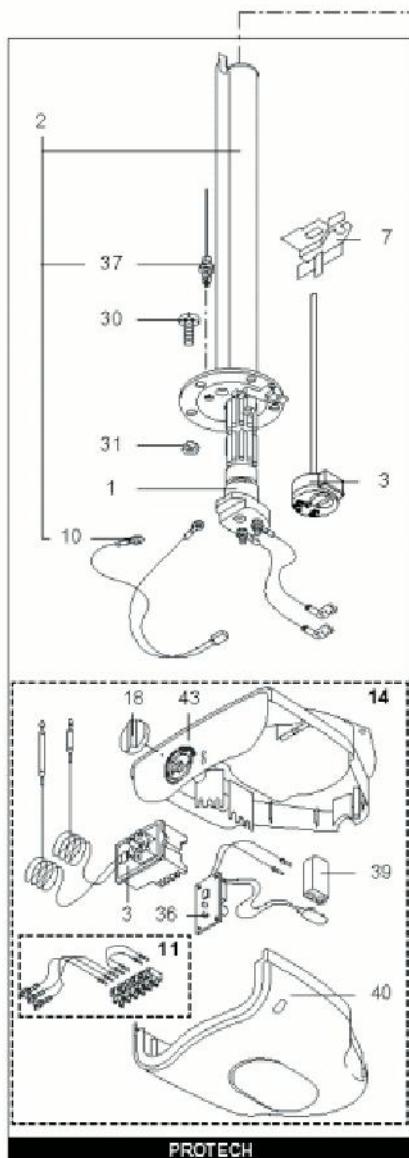
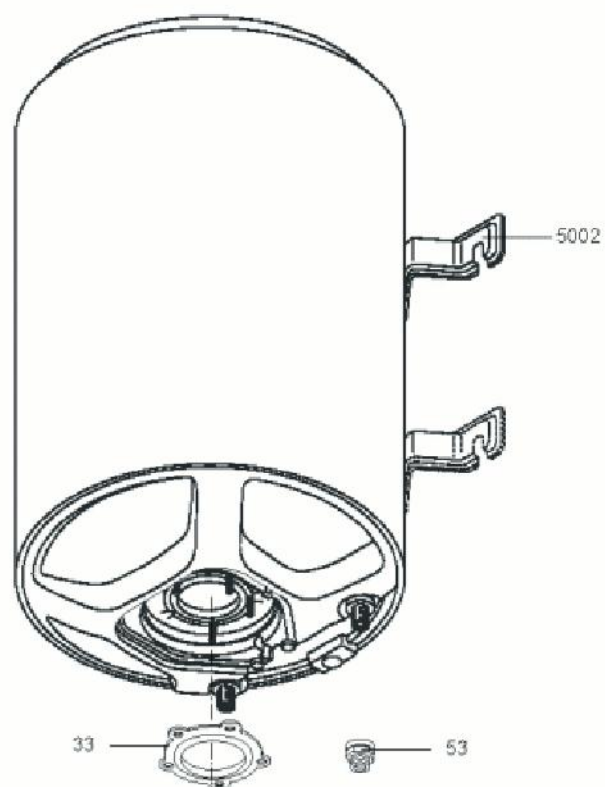

Table		PROTECH							
Rep.	Référence	ALIAS	Désignation	Remplacé par	Date début	Date fin	Multiple de vente	Tarif Public Unitaire HT	
1	60000439		RESISTANCE STEATITE 2400W	60000439-01			1		
2	60000440		EMBASE + ANODE				1		
3	60000773		CIRCUIT IMPRIME DE REGULATION				1		
10	60000344		CABLAGE ELECTRODE				1		
11	60000449		CABLAGE RESISTANCE > C.I.				1		
12	60000451		CABLAGE THERMISTANCE				1		
13	60000450		CABLAGE RESISTANCE > C.I.				1		
18	60000441		MOLETTE DE REGLAGE				1		
27	60000478		PORTE BATTERIE				1		
30	918001		VIS M8X25				1		
30	918064		VIS DE FIXATION EMBASE M 8-20				1		
31	918004		ECROU FIXATION EMBASE M8				1		
33	924001		JOINT BRIDE 5 TROUS D.75				1		
34	60000448		CABLAGE ELECTRODE > C.I.				1		
36	60000442		CIRCUIT IMPRIME DE PUISSANCE				1		
37	340406		ANODE PROTECH				1		
39	60000443		BATTERIE AA				1		
40	60000444		COUVERCLE BOITIER				1		
43	65101466		FOND DE BOITIER				1		
53	926195		RACCORDS DIELECTRI. 3/4-75 A 300L KIT				1		
54	60000477		CABLAGE INTERCONNEXION				1		
66	60000445		FACE ADHESIVE				1		
67	60000446		THERMISTANCE				1		
72	60000476		FAISCEAU DE CABLES				1		
5002	912006		PATTE MURALE D:470-505-560				1		