



LISTE DE PIECES

13/04/2016

<i>Produit</i>	3010194 - ARI 200 STAB 560 PTEC MT
<i>Modèle</i>	200L STABLE STEATITE
<i>Marque</i>	ARISTON
<i>Date</i>	23/11/2015

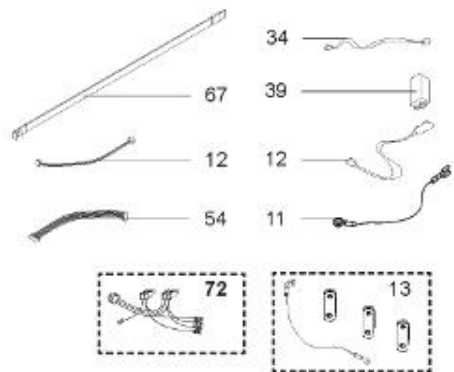
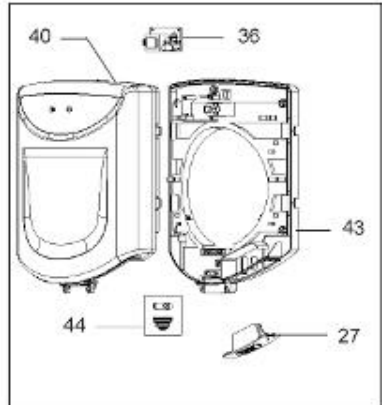
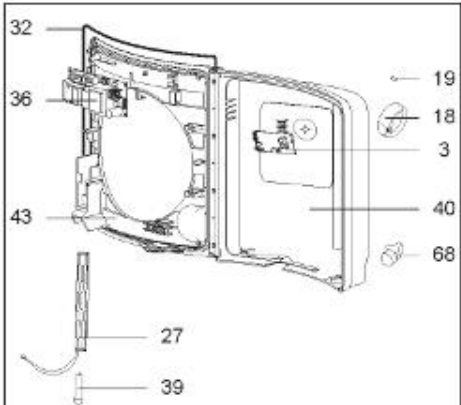
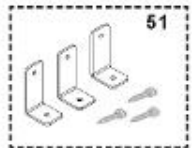
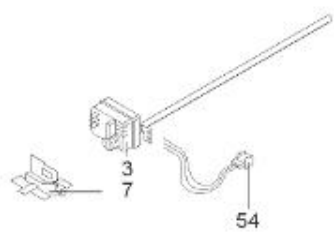
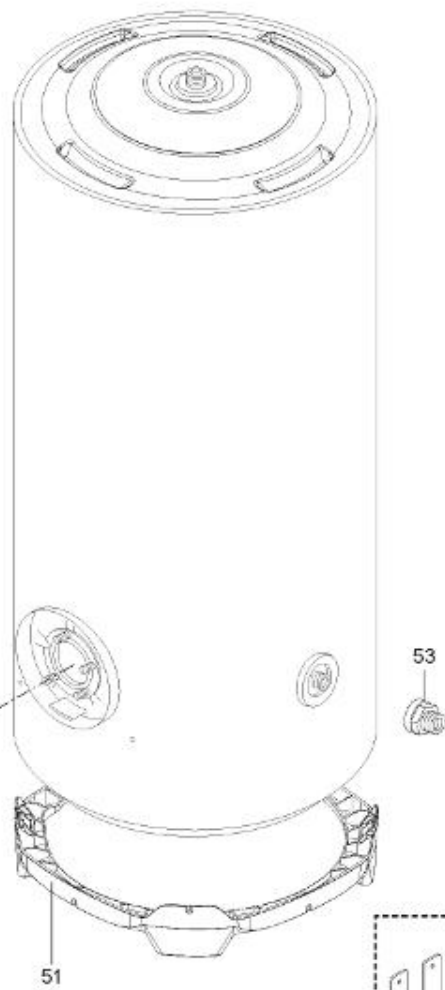
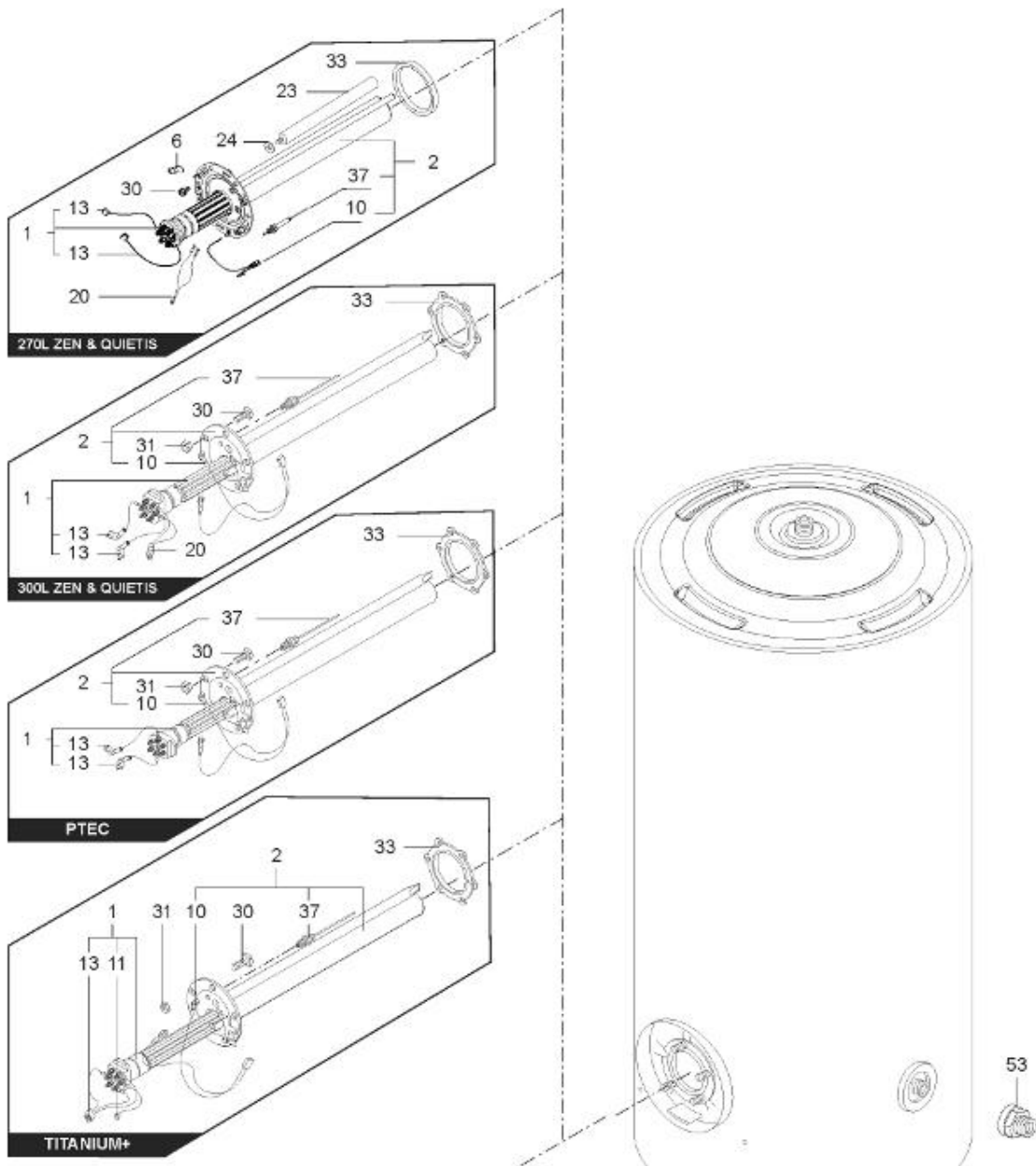

Table		STABLE							
Rep.	Référence	ALIAS	Désignation	Remplacé par	Date début	Date fin	Multiple de vente	Tarif Public Unitaire HT	
1	396010-01		RESISTANCE STEATITE 3000W D.39				1		
2	60000440		EMBASE + ANODE				1		
3	992162		THERMOSTAT A CANNE				1		
7	926324		SEPARATEUR PLASTIQUE				1		
10	60000344		CABLAGE ELECTRODE				1		
12	60000938		CABLAGE BATTERIE				1		
13	61401779		CABLAGE (BRUN)				1		
13	61401780		CABLAGE (VERT)				1		
13	61401781		CABLAGE (VIOLET)				1		
19	998577		VITRE LED L=14.2				1		
30	918064		VIS DE FIXATION EMBASE M 8-20				1		
31	918004		ECROU FIXATION EMBASE M8				1		
33	924001		JOINT BRIDE 5 TROUS D.75				1		
34	60000939		CABLAGE ELECTRODE > C.I.				1		
36	60000936		CIRCUIT IMPRIME				1		
37	340406		ANODE PROTECH				1		
39	925298		BATTERIE 9V-170 MAH				1		
40	60000940		COUVERCLE BOITIER				1		
43	60000513		FOND DE BOITIER				1		
51	60000803		SUPPORT D:505-560				1		
53	926195		RACCORDS DIELECTRI. 3/4-75 A 300L KIT				1		
54	60000801		CABLAGE THERMOSTAT				1		
72	60000935		CABLAGE PUISSANCE				1		