



LISTE DE PIECES

13/04/2016

<i>Produit</i>	3000033 - 200 AXST TITANIUM +
<i>Modèle</i>	200L STABLE STEATITE
<i>Marque</i>	ARISTON
<i>Date</i>	19/04/2012

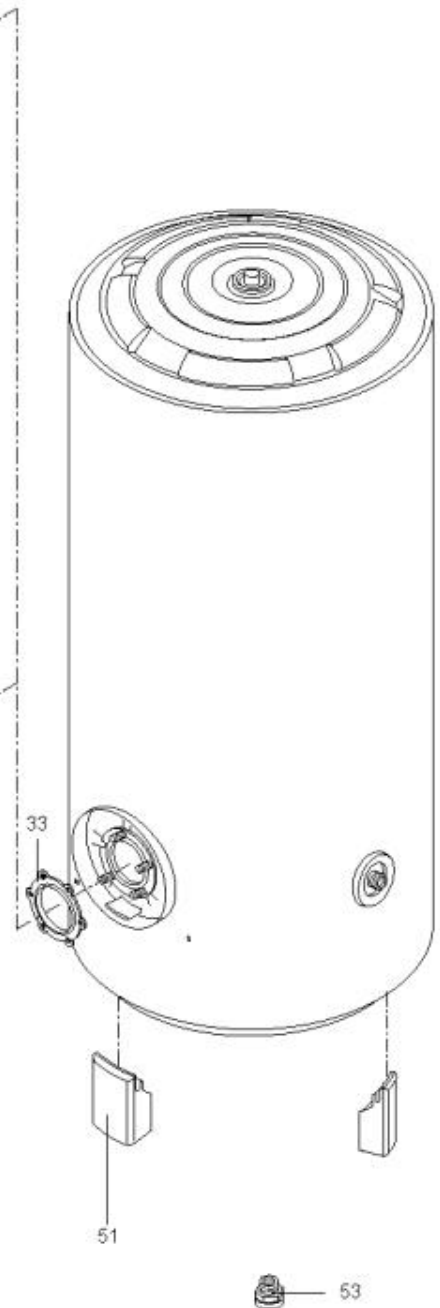
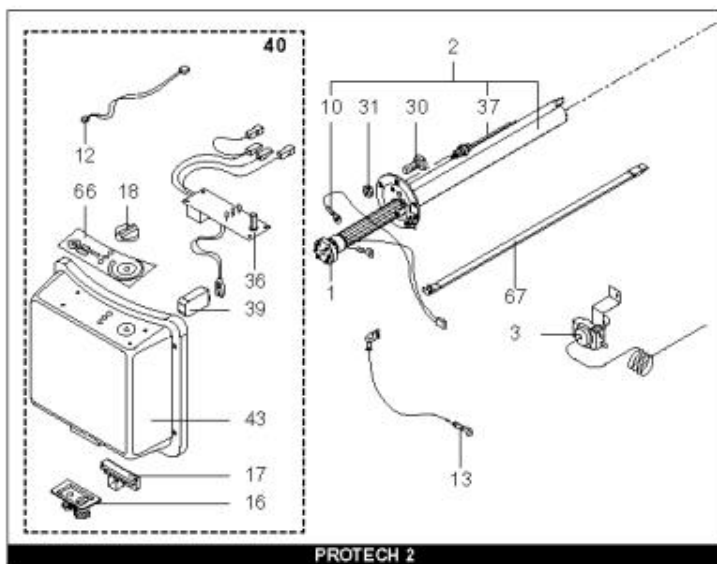
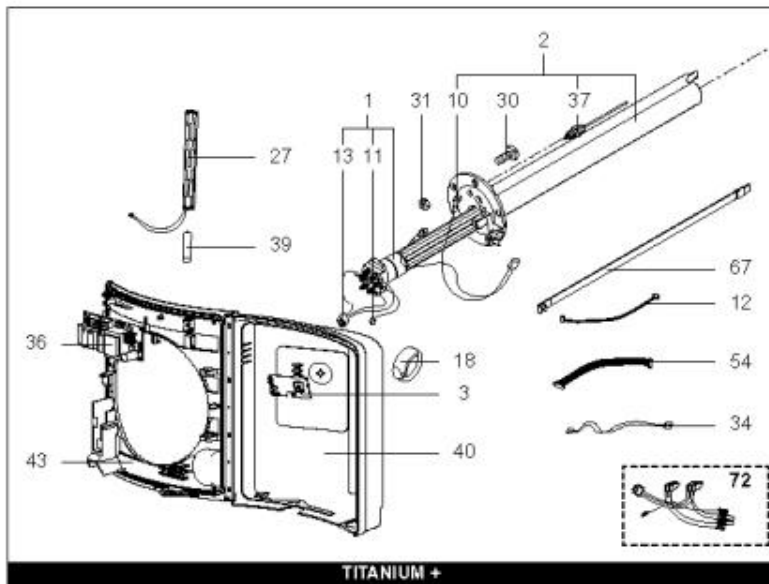

Table		AXSM PROTECH 2							
Rep.	Référence	ALIAS	Désignation	Remplacé par	Date début	Date fin	Multiple de vente	Tarif Public Unitaire HT	
1	396010-01		RESISTANCE STEATITE 3000W D.39				1		
2	60000440		EMBASE + ANODE				1		
3	60000773		CIRCUIT IMPRIME DE REGULATION				1		
10	60000344		CABLAGE ELECTRODE				1		
11	60000449		CABLAGE RESISTANCE > C.I.				1		
12	60000474		CABLAGE THERMISTANCE				1		
13	60000450		CABLAGE RESISTANCE > C.I.				1		
18	60000441		MOLETTE DE REGLAGE				1		
27	60000514		PORTE BATTERIE				1		
30	918064		VIS DE FIXATION EMBASE M 8-20				1		
31	918004		ECROU FIXATION EMBASE M8				1		
33	924001		JOINT BRIDE 5 TROUS D.75				1		
34	60000475		CABLAGE ELECTRODE > C.I.				1		
36	60000442		CIRCUIT IMPRIME DE PUISSANCE				1		
37	340406		ANODE PROTECH				1		
39	60000443		BATTERIE AA				1		
40	60000472		COUVERCLE BOITIER				1		
43	60000473		FOND DE BOITIER				1		
51	926136		PIED HT 100				1		
53	926195		RACCORDS DIELECTRI. 3/4-75 A 300L KIT				1		
54	60000504		CABLAGE INTERCONNEXION				1		
67	60000446		THERMISTANCE				1		
72	60000503		FAISCEAU DE CABLES			12/09	1		
72	60001501		FAISCEAU DE CABLES		12/09		1		