



LISTE DE PIECES

12/04/2016

<i>Produit</i>	3040122 - ARI 150 VERT 555 PTEC MO
<i>Modèle</i>	150L VERTICAL STEATITE
<i>Marque</i>	ARISTON
<i>Date</i>	15/10/2015

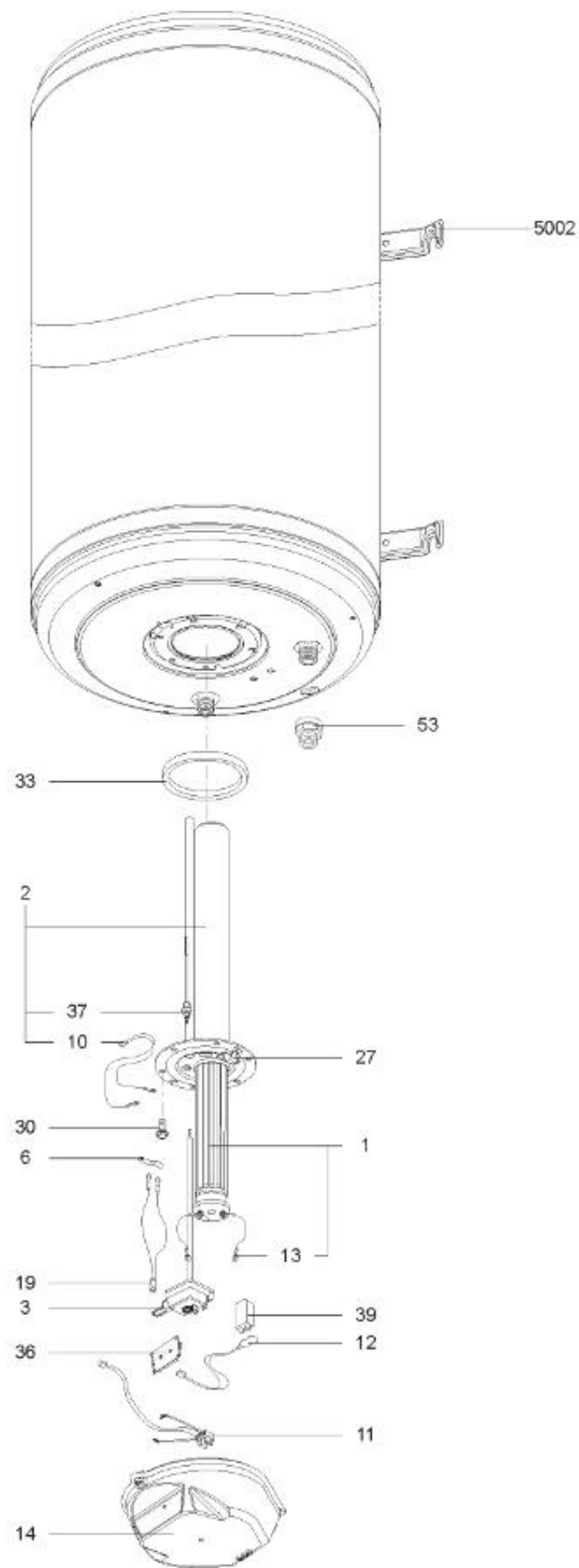

Table		V 555 PROTECH							
Rep.	Référence	ALIAS	Désignation	Remplacé par	Date début	Date fin	Multiple de vente	Tarif Public Unitaire HT	
1	61400608-01		RESISTANCE STEATITE 1800W D.50				1		
2	60000964		EMBASE + ANODE PROTECH				1		
3	60000683		THERMOSTAT A CANNE L:450				1		
6	60072531		PATTE DE FIXATION				1		
10	60000382		CABLAGE ELECTRODE				1		
11	60000386		CABLAGE BORNIER > THERMOSTAT				1		
12	60000385		CABLAGE BATTERIE				1		
13	60000187		CABLAGE RESISTANCE > THERMOSTAT				1		
14	60002074		CAPOT				1		
19	60000802		LAMPE TEMOIN				1		
27	60000383		SUPPORT BORNIER				1		
30	60000681		VIS DE FIXATION EMBASE M 8-14 (6 PCES)				1		
33	60000682		JOINT BRIDE D:121.7-105-11.5				1		
36	60000384		CIRCUIT IMPRIME (6 mA)				1		
37	340406		ANODE PROTECH				1		
39	925298		BATTERIE 9V-170 MAH				1		
53	926195		RACCORDS DIELECTRI. 3/4-75 A 300L KIT				1		
5002	912006		PATTE MURALE D:470-505-560				1		