

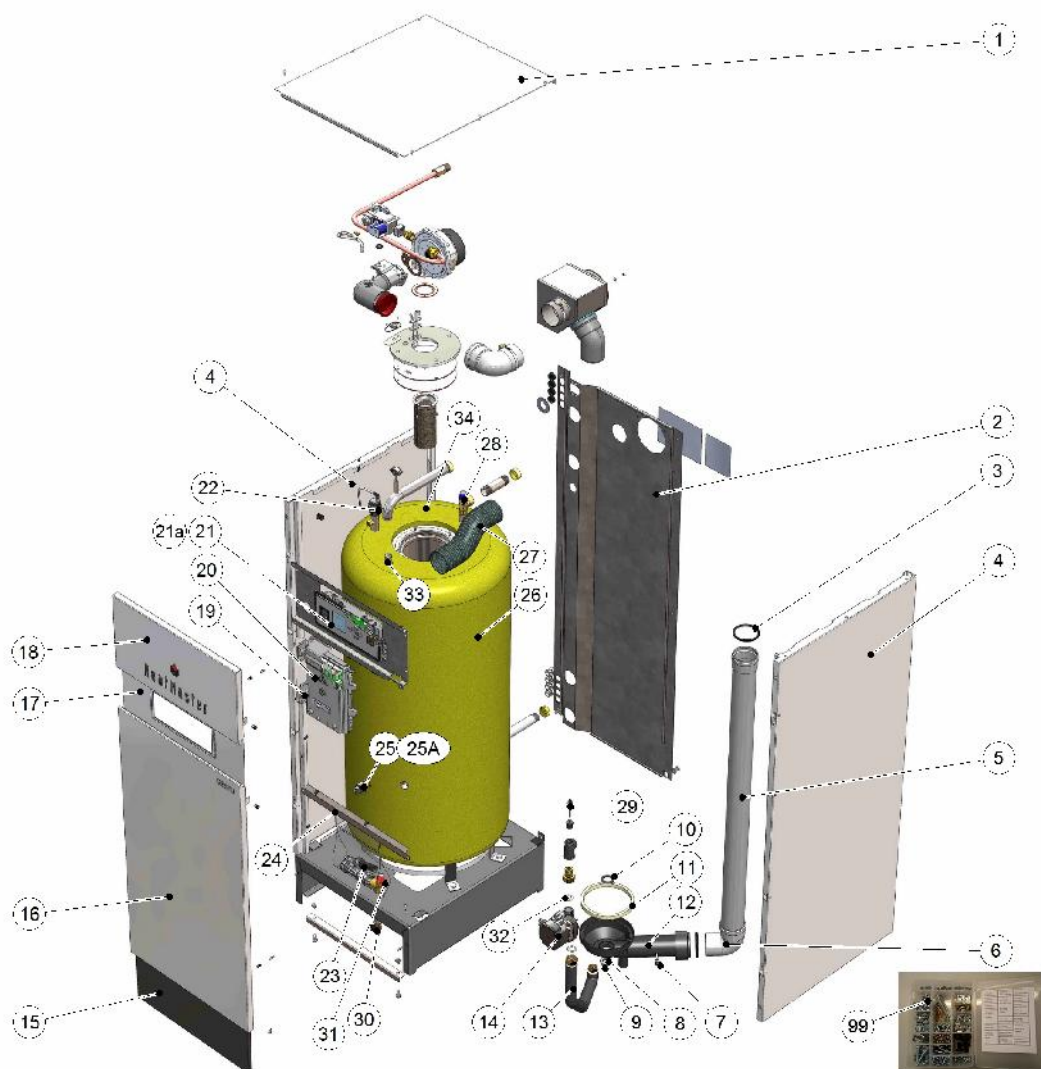























HeatMaster 25-35-45TC V15



|  | Code | Quant. | Photo | Description | De --- A --- | Remarque |
|---|----------|--------|---|---------------------------------------|--------------|----------|
| 99 | 10800265 | 1 |  | Kit visserie chd.condens. | 1/1/2016- | |
| 1 | 21475514 | 1 | | Couvercle HMTC petit V15 | 1/1/2016- | |
| 2 | 20474514 | 1 | | Arrière HMTC petit V15 | 1/1/2016- | |
| 3 | 557A0105 | 2 |  | Joint à lèvre DN80 HR-EPDM noir | 1/1/2016- | |
| 4 | 28471514 | 2 | | Lat.G&D cpl HMTC petit V15 | 1/1/2016- | |
| 5 | 537D6237 | 1 | | Tube fumée D80 L1220 HM25-35-45TC | 1/1/2016- | |
| 6 | 537D6403 | 1 |  | Coude 90° MF DN80 PP gris+joint | 1/1/2016- | |
| 7 | 5476g054 | 1 |  | Sonde NTC 12K d5x50 1/8' +conn. Molex | 1/1/2016- | |
| 8 | 4779A011 | 1 |  | Ecrou 3/4 DIN431A inox HMTC | 1/1/2016- | |
| 9 | 557A0147 | 1 |  | Joint 24x14x2 novapress basic | 1/1/2016- | |
| 10 | 557A0144 | 1 |  | Joint 28-45x5 Viton bac condens.HMTC | 1/1/2016- | |
| 11 | 557A0141 | 1 | | Joint DI:166 bac.condens.HM35TC | 1/1/2016- | |
| 12 | 10800261 | 1 | | Bac condens.PPS+joint HM35TC-25 C | 1/1/2016- | |









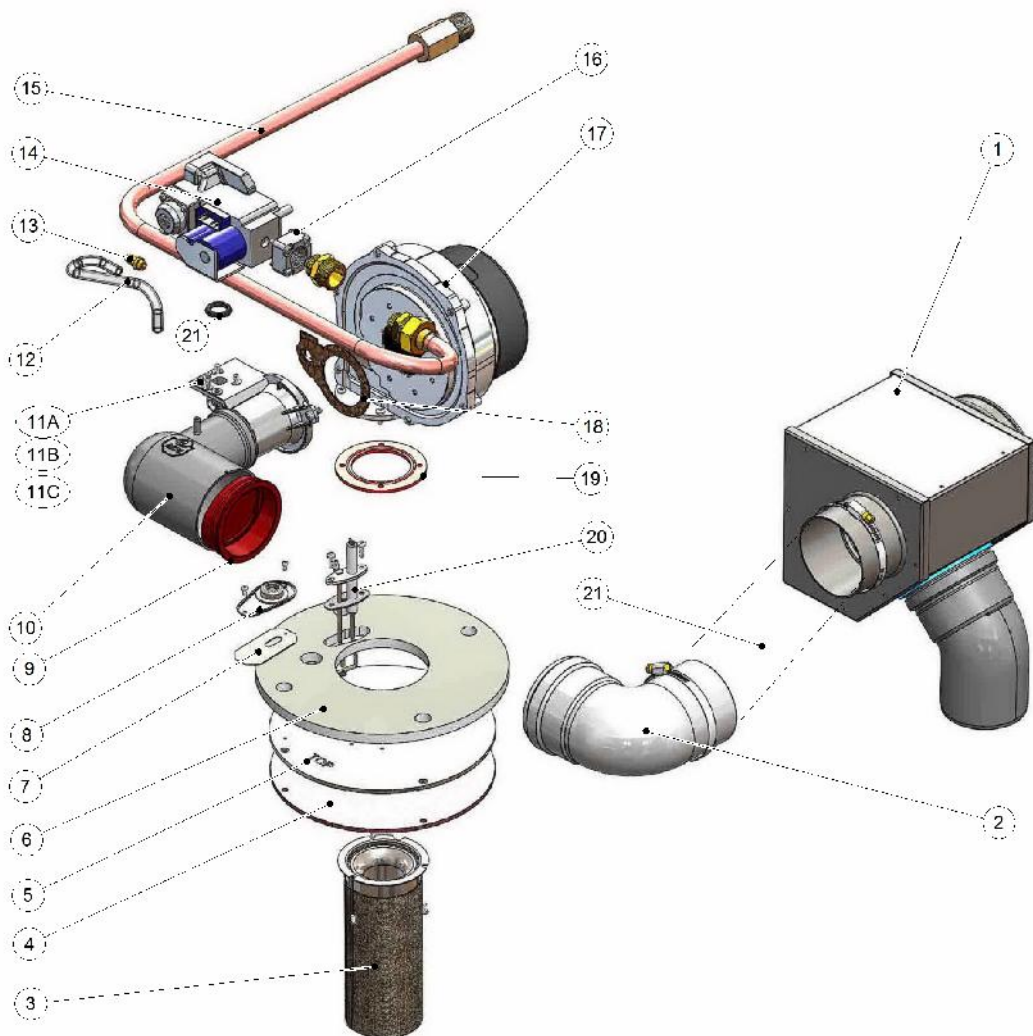

pieces-rechanges-chaudieres.fr

| | | | | | |
|-----|----------|---|---|--|-----------|
| 13 | 507F4346 | 1 |  | Tube de recirculation HMTC petit V15 | 1/1/2016- |
| 14 | 557A4036 | 1 | | Circul.UPM3 15-75 L130 G1 | 1/1/2016- |
| 15 | 28478514 | 1 | | Avant socle cpl HMTC petit V15 | 1/1/2016- |
| 16 | 28473514 | 1 | | Avant inf.cpl HMTC petit V15 | 1/1/2016- |
| 17 | 21477514 | 1 | | Avant tabl.HMTC petit V15 | 1/1/2016- |
| 18 | 28476514 | 1 | | Avant sup.cpl.HMTC petit V15 | 1/1/2016- |
| 19 | 5476V056 | 1 |  | Charnière boîtier elec. Prest.V14 | 1/1/2016- |
| 20 | A1002935 | 1 | | Tableau complet HM small TC V15 | 1/1/2016- |
| 21a | A1002098 | 1 | | Display board DSP49G2243 version C 256 k | |
| 21 | A1002229 | 1 | | Boîtier display cpl. Ver.C ACVmax | 1/1/2016- |
| 22 | 557A3007 | 1 |  | Purgeur air auto.composite P32 V14 | 1/1/2016- |
| 23 | 557A8004 | 1 |  | Siphon DH50+bille+bague+flexible:60cm | 1/1/2016- |
| 24 | 2047A514 | 1 | | Raidisseur lat.HMTC petit V15 | 1/1/2016- |
| 25A | 507F4289 | 1 |  | Epingle capteur sonde Prest.V14 | 1/1/2016- |
| 25 | 557A6010 | 1 |  | Capteur de pression Prest.V14 | 1/1/2016- |
| 26 | 30540660 | 1 | | Corps moussé HMTC petit volume V15 | 1/1/2016- |
| 27 | 537D6513 | 1 |  | Flexible Masterflex D80 L350 | 1/1/2016- |
| 28 | A1002104 | 1 |  | Soupape secur.8bar 3/4 sanit | 1/1/2016- |
| 29 | 5476g054 | 1 |  | Sonde NTC 12K d5x50 1/8' +conn. Molex | 1/1/2016- |
| 30 | 55426001 | 1 |  | Robinet de vidange 1/2 | 1/1/2016- |
| 31 | 557A1089 | 1 | | Soupape sécur.3bar 82kW 1/2->1/2 | 1/1/2016- |
| 32 | 557A0050 | 2 |  | Joint 30x20x2 fibre | 1/1/2016- |
| 33 | 39438027 | 1 |  | Doigt de gant inox 1/2x500 | 1/1/2016- |
| 34 | 5476G047 | 1 |  | Sonde NTC 12K d5x18 1/8 +Molex conn. | 1/1/2016- |











Burner HM 25-35-45TC V15



|  | Code | Quant. | Photo | Description | De --- A --- | Remarque |
|---|----------|--------|---|---|--------------|----------|
| 1 | 507F4345 | 1 |  | Adapt.ventouse HMTC petit V15 | 1/1/2016- | |
| 2 | 537D6403 | 1 |  | Coude 90° MF DN80 PP gris+joint | 1/1/2016- | |
| 3 | 537DZ050 | 1 | | Rampe NIT D70 L177 | 1/1/2016- | |
| 4 | A1002429 | 1 | | Isol.porte brûleur 2 in1 HMTC PV V15 | 1/1/2016- | |
| 5 | 507F4351 | 1 | | Porte brûleur HMTC petit V15 | 1/1/2016- | |
| 6 | 51700145 | 1 |  | Isol. sup. brûleur HMTC petit V15 | 1/1/2016- | |
| 7 | 557A0149 | 1 |  | Joint regard flamme monobl(68x32x2 GPE) | 1/1/2016- | |
| 8 | 507F4283 | 1 |  | Kit regard flamme monobloc | 1/1/2016- | |
| 9 | 557A9000 | 1 |  | Clapet anti-retour prise d'air DN80 | 1/1/2016- | |
| 10 | 537D6511 | 1 |  | Coude réduc. 80->50 HMTC V15 + joint | 1/1/2016- | |
| 11A | 537D4034 | 1 |  | Venturi VF002 | 1/1/2016- | HM25TC |
| 11B | 537D4067 | 1 | | Venturi VF003 | 1/1/2016- | HM35TC |
| 11C | 537D6038 | 1 |  | Venturi VF001 | 1/1/2016- | HM45TC |

pieces-rechanges-chaudieres.fr

| | | | | | |
|----|----------|---|---|--|-----------|
| 12 | 49437026 | 1 |  | Flexible silicone 5x9 | 1/1/2016- |
| 13 | 53437039 | 1 |  | Prise de pression D:8,5 M5 | 1/1/2016- |
| 14 | 537D4009 | 1 |  | Vanne gaz VK4115V1014 | 1/1/2016- |
| 15 | 507F4111 | 1 | | Tube gaz HM25-35-45TC | 1/1/2016- |
| 16 | 53402088 | 1 |  | Bride droite vanne gaz 1/2 | 1/1/2016- |
| 17 | 537d3059 | 1 | | Ventil.RG128-1300 230V rotated 120° | 1/1/2016- |
| 18 | 557A0026 | 1 |  | Joint (liège) venturi | 1/1/2016- |
| 19 | 557A0199 | 1 |  | Joint silicone ventil. HMTc PV V15 | 1/1/2016- |
| 20 | A1002510 | 1 | | Kit electrode P24-32-100-120 V14+vis+joint | 1/1/2016- |
| 21 | 537D6513 | 1 |  | Flexible Masterflex D80 L350 | 1/1/2016- |
| 22 | 557A0098 | 1 |  | Joint vanne gaz-venturi | 1/1/2016- |