

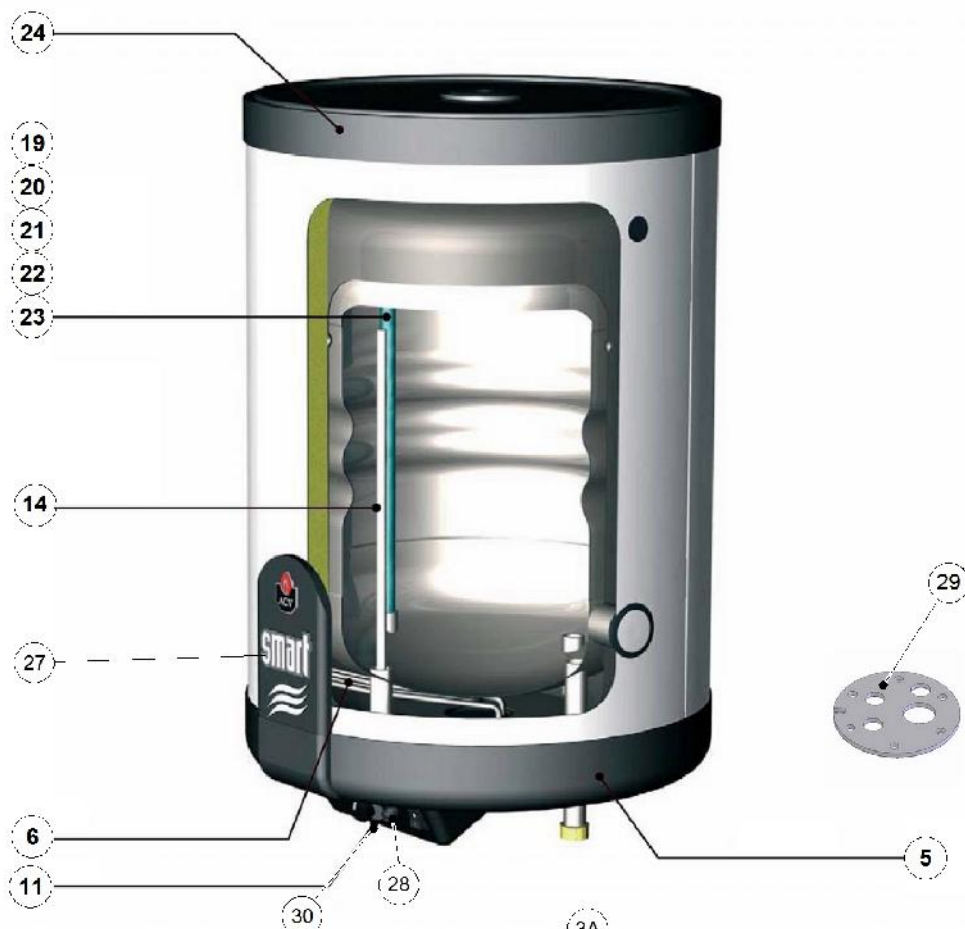











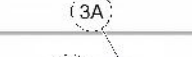

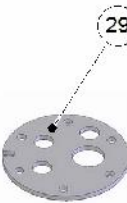





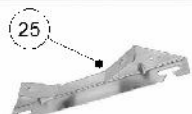







Smart EW100-240



	Code	Quant.	Photo	Description	De --- A ---	Remarque
1	55445006	1		Purgeur air man.1/2		
2	49410036	1		Brise jet L.273mm PP. noir		
3	54442045	1		T-stat 0-90°C cap1500 bulb6 TU-L-DT	-1/1/2016	
3A	A1002038	1		T-stat 0-80°C cap1500 bulb6 TU-L-DT	1/1/2016-	
4	54764021	1		Bouton rotatif thermostat-trait blanc		
5	497B5011	1		Calotte sanitaire Smart SLEW		
6	5476D001	1		Resist.chauff.2,2kW HLE-SLEW-Comfort E		
8	54766018	1		Voyant rouge câble sil. 200mm		
9	507F4183	1		Rondelle refroid.porte-fusible SLEW		
9	5476C011	1		Fusible 6,3x32 12.5AT lent		
9	5476C012	1		Porte-fusible 6,3x32 13A 250V (FX0415)		
10	54764037	1		T-stat+reset 96°C 2pole (type TOD)	1/10/2013-	prev: 54764010

# pieces-rechanges-chaudieres.fr

11	24614161	1		Boitier câblé SLEW-Comfort E ->A1002121	-1/1/2016	
12	54428107	1		Interrupt.Ete/Hiv 22x30 dbl.inv.		
13	55412023	1		Joint 135-80x5 Resist.chauff.HLE		
14	39438027	1		Doigt de gant inox 1/2x500		
19	497B0003	1		Plonge PVCc 19,5x700 perç.lat.		SLEW 100
20	497B0051	1		Plonge PVCc 19,5x840 perç.lat.		SLEW 130
21	497B0006	1		Plonge PVCc 19,5x1000 perç.lat.	1/7/2014-	SLEW 160
22	497B0027	1		Plonge PVCc 19,5x1280 perç.lat.	1/7/2014-	SLEW 210
23	497B0028	1		Plonge PVCc 19,5x1540 perç.lat.	1/7/2014-	SLEW 240
24	497b5015	1		Calotte inférieure Smart 100 -> 240 V07	1/7/2007-	
25	50423201	2		Fixation murale HL-ECO-Smart		
26	54763020	1		Thermomètre 0-120°C Dp:52 SmartLine	1/7/2012-	
27	497B4001	1		Support logo SMART Line 100-240-320		
28	10800193	1		Kit porte-fusible SLEW		
29	42402075	1		Bride zinguée 140x6 resistance HVS		
30	A1002121	1		Boitier câblé SLEW-Comfort E V15	1/1/2016-	